

HOT WATER FIREPLACE INSERT BEF AQUATIC WH 60 CP IN ACCORDANCE WITH EN 13 229

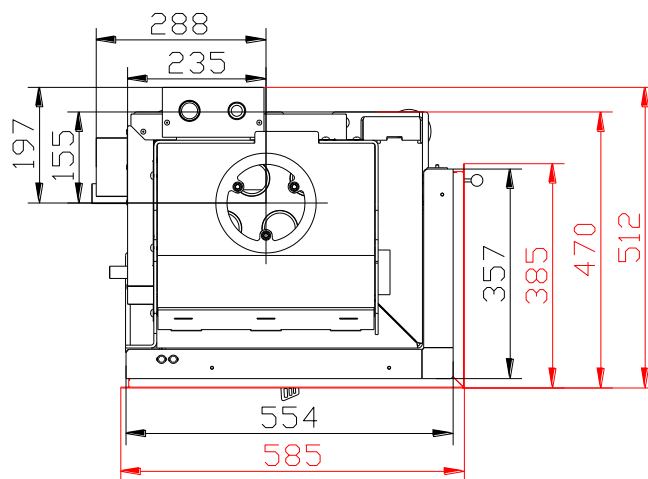
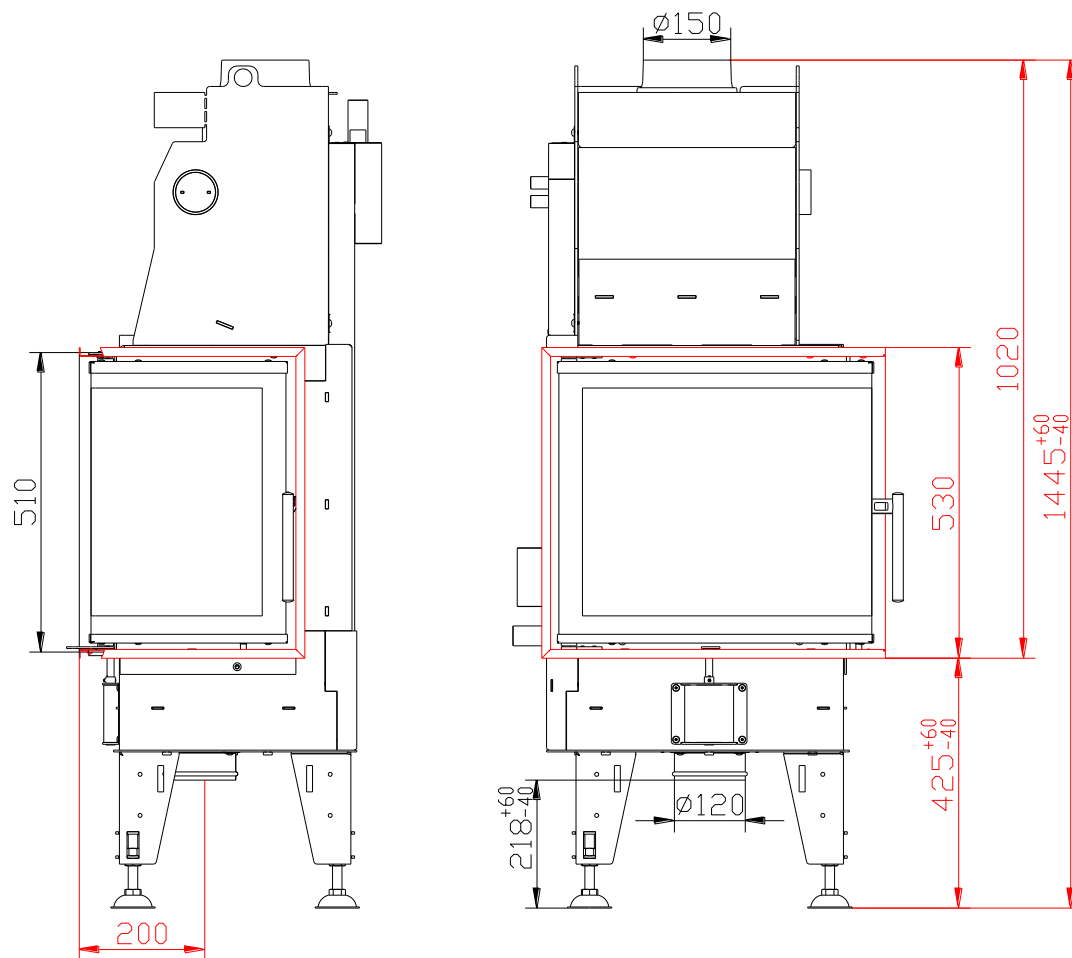

HOT WATER FIREPLACE INSERT BEF AQUATIC WH 60 CP IN ACCORDANCE WITH EN 13 229

Technical data:

		Closed firebox
Nominal heat output	kW	9
Efficiency	%	86
Output into water	kW	6,3
Volume flow of combustion products	g/s	7,1
Flue-gas temperature	°C	210
Min. feed pressure at nominal heat output	Pa	12
Fuel		wood (beech logs)
Fuel consumption per hour	kg/h	2,81
CO emission in burnt gas (in relation to 13% O ₂)	%	0,07
Dust in flue-gas (in relation to 13% O ₂)	mg/Nm ³	23
Smoke flue diameter	mm	150
Weight	kg	161

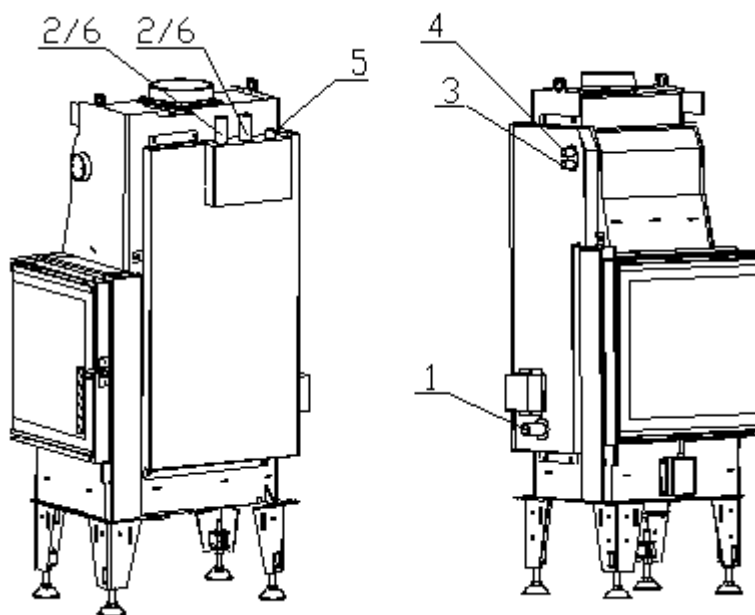

- 1 – Cold water input into water exchanger (reverse), external thread 1“
- 2 – Warm water output from water exchanger (rising pipe), external thread 1“
- 3 – Cold water input for coolant loop , external thread 1/2“
- 4 – Warm water output from coolant loop, external thread 1/2“
- 5 – Input for bleed valve, internal thread 1/2”
- 6 – Thermic security sensor, internal thread 1”

Set of carcon firebox:

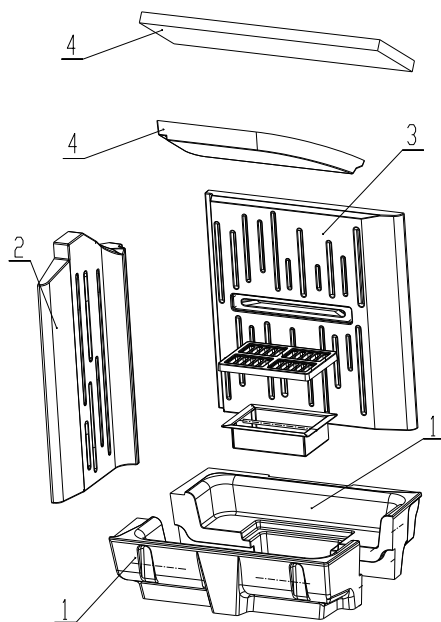

List of spare parts:

- 1. Bottom
- 2. Side piece
- 3. Back
- 4. Deflector
- 5. Cast iron grate
- 6. Ashtray

For details see Installation and Service Instructions.